

**Audi**

**Important!**

Please give copies to  
all your Audi Technicians

# Technical Bulletin

Subject: **Compact Disc Changer, Installation Instructions**

Group: **91**

Number: **00-07**

Model(s): **TT Coupe**

**2000, 2001**

Date: **Nov. 8, 2000**

Supersedes T.B. Group 91 Number 99-02 dated Apr. 20, 1999

## Condition

The following pages contain CD Changer installation instructions for the model listed above.

Description	Part No:	Qty
CD Changer	8N8 035 111A	1
Installation kit	8N8 051 229A	1

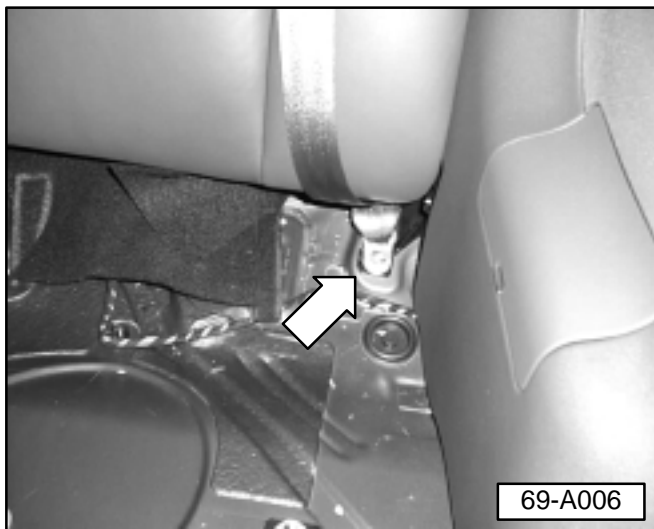

## Rear seat, removal

- Remove rear seat bottom.
- ◀ - Disconnect left rear seat belt at body anchorage point.
- Remove left rear seat back.
- Disconnect left front seat belt body anchor at floor (located at rear of front seat).

### **CAUTION!**

***Part numbers are for reference only. Always check with your Parts Dept. for the latest parts information.***

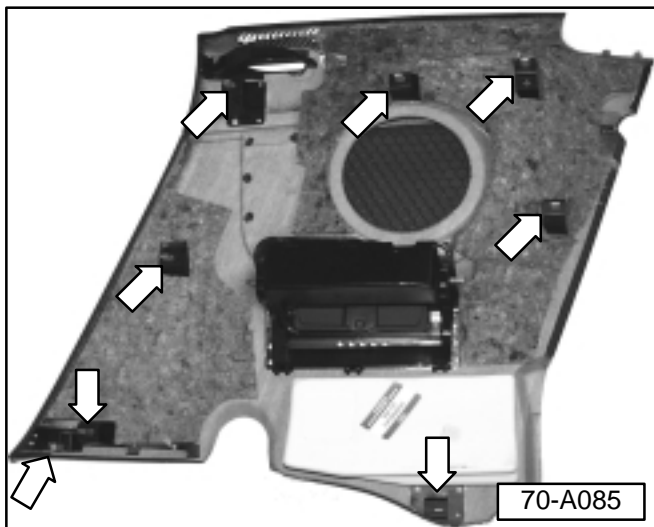

## Rear trim panel, removal

- Remove left rear seat back lock pin.
- ◀ - Carefully remove left rear trim panel starting at top rear of panel. Fastening clips are as shown -arrows-.
- Once panel is removed, remove and discard storage compartment from backside of panel (door and trim should remain attached to panel).

(Cont. on Page 2)

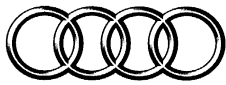

**Important!**

**Audi**

Please give copies to  
all your Audi Technicians

# Technical Bulletin

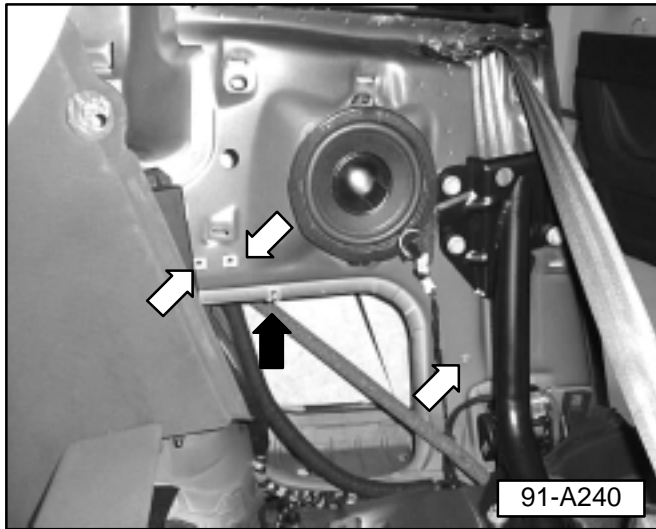

## CD changer bracket fasteners, Installing

- ◀ – Snap in 3 supplied metal screw inserts at locations shown -white arrows-.
- Install speed nut to sheet metal flange -black arrow-.

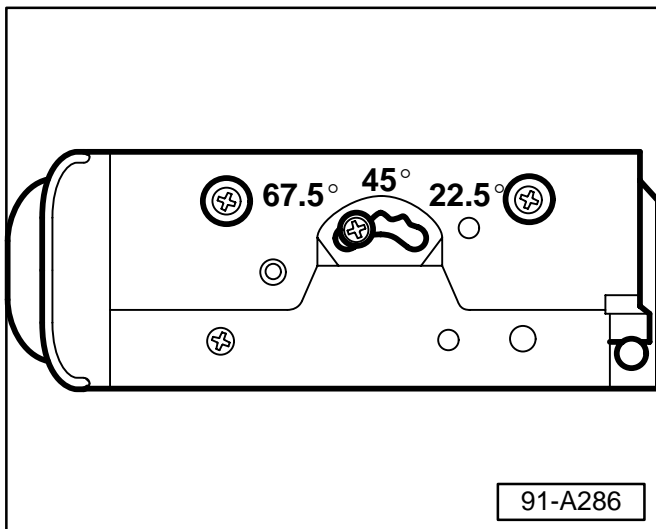

- ◀ – Set both CD changer horizontal / vertical switches to 67.5° (located on each side of CD changer).



## CD changer to bracket, assembling

- ◀ – Attach mounting bracket to CD changer using 6 supplied screws.

(Cont. on Page 3)

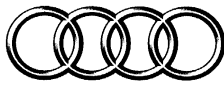

**Important!**

**Audi**

Please give copies to  
all your Audi Technicians

# Technical Bulletin



## CD changer assembly, installing into vehicle

- Install CD bracket assembly into vehicle using 4 supplied screws.
- Connect harness to CD changer.
- ◀ - Attach harness to clip mounted on CD changer bracket.
- Check CD changer operation.
- Reinstall left rear trim panel.
- Reinstall left rear seat back lock pin.
  
- Reinstall rear seat back and align lock pin.
- Reinstall left rear seat belt anchor and bolt (tightening torque 55 Nm).
- Reinstall rear seat bottom.
- Reinstall left front seat belt body anchor and bolt (tightening torque 55 Nm).
- Code radio to include CD changer (see coding table in Repair Manual CD-ROM *Radio, Telephone, Navigation* Group 01 On Board Diagnostic (OBD) Code Control Module (function 07).

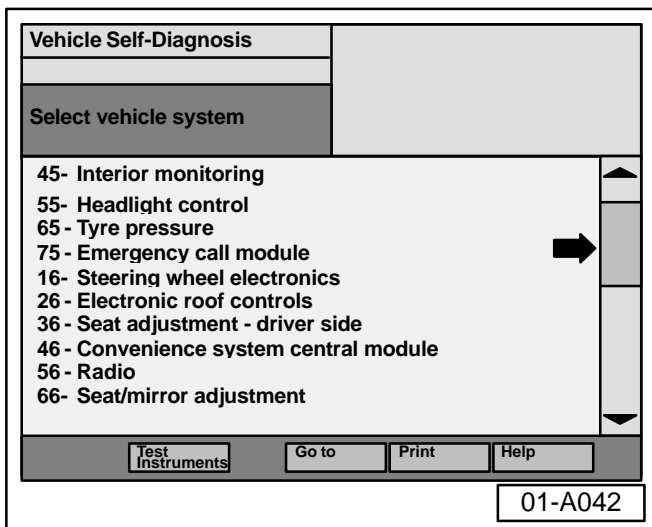

## Radio, coding using VAS 5051 Diagnostic tool

- Connect the VAS 5051 Diagnostic tool.
- Switch ignition ON.
- From VAS 5051 Start-up screen, select "Vehicle self diagnosis".
- ◀ - Select vehicle system "56- Radio" (use the scroll bar at right side of screen if necessary).

(Cont. on Page 4)

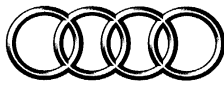

# Important!

## Audi

Please give copies to  
all your Audi Technicians

# Technical Bulletin

Vehicle Self-Diagnosis	56 - Radio 8N0035186A Radio D03 Coding 515 Dealership number XXXX
Select diagnosis function	
02 - Interrogate fault memory 03 - Final control diagnosis 04 - Basic settings 05 - Erase fault memory 06 - End output 07 - Code control module 08 - Read data block 09 - Reading individual measuring value 10 - Adaption 11 - Login procedure	
◀ Test Instruments	Go to Print Help
01-A043	

◀ - Select Diagnosis function "07 - Code control module" (arrow).

Vehicle Self-Diagnosis	56 - Radio 8N0035186A Radiod03 Coding 515 Dealership number XXXX															
07 - Code control unit																
Enter display group max. input value = 32767																
	<table border="1"> <tr><td colspan="3">00517</td></tr> <tr><td>1</td><td>2</td><td>3</td></tr> <tr><td>4</td><td>5</td><td>6</td></tr> <tr><td>7</td><td>8</td><td>9</td></tr> <tr><td>C</td><td>0</td><td>Q</td></tr> </table>	00517			1	2	3	4	5	6	7	8	9	C	0	Q
00517																
1	2	3														
4	5	6														
7	8	9														
C	0	Q														
◀ Test Instruments	Go to Print Help															
01-A044																

◀ - When keypad appears, input "00517" then press "Q".

Vehicle Self-Diagnosis	56 - Radio 8N0035186A Radiod03 Coding 517 (515) Dealership number XXXX
07 - Code control unit	
Coding of vehicle system completed	
◀ Test Instruments	Go to Print Help
01-A045	

◀ Left side of screen shows "Coding of vehicle system complete" new coding 517 (arrow) old coding is in parenthesis (515).

Select back arrow ◀ .

- Select Diagnosis function "02 - Interrogate fault memory".
- Clear any stored DTC's.
- Select "Go to" then select "Exit"
- Remove VAS 5051 Diagnostic tool.

(Cont. on Page 5)



**Important!**

**Audi**

Please give copies to  
all your Audi Technicians

# Technical Bulletin

When procedure applies to vehicles within the New Vehicle Limited Warranty, use the following:

Part Identifier:	9160
Labor Operation:	91601950    20 TU Side Trim panel Removed